

Instruction Manual

Alpha pH 1000

pH/ORP Controller/ Transmitter

pH / mV / °C



ISO 9001
CERTIFIED

CE

68X216801 | Rev.2 | Mar 2008

EUTECH
INSTRUMENTS
Technology Made Easy ...

Preface

This manual serves to explain the use of the Alpha pH1000 pH/ORP process controller/transmitter. The manual functions in two ways, firstly as a step by step guide to help the user operate the instrument. Secondly, it serves as a handy reference guide. This instruction manual is written to cover as many anticipated applications of the Alpha pH1000 pH/ORP process controller/transmitter. If you have doubts in the use of the instrument, please do not hesitate to contact the nearest Authorized Distributor.

Thermo Scientific will not accept any responsibility for damage or malfunction of the unit due to improper use of the instrument.

The information presented in this manual is subject to change without notice as improvements are made, and does not represent a commitment on part of Thermo Fisher Scientific.

Copyright ©1997

All rights reserved

Safety Information

The Controller/ Transmitter shall be installed and operated only in the manner specified in this Instruction manual. Only skilled, trained or authorized person should carry out installation, setup and operation of the instrument.

Before powering up the unit, make sure that power source is connected to it as specified on the top label. Failure to do so may result in permanent damage of the unit.

The unit has live and exposed parts inside. If it has to be opened, make sure that power to the unit is off and disconnected.

The unit is Fuse protected. In the event the fuse has to be replaced, use only those as specified in the manual.

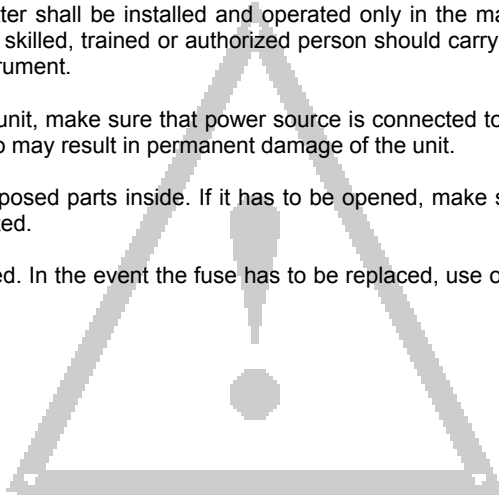

TABLE OF CONTENTS

1	INTRODUCTION	1
1.1	Description of Unit.....	1
1.2	Applications.....	1
2	ASSEMBLY AND INSTALLATIONS	2
2.1	Measurement and Control System.....	2
2.2	Unit Dimensions.....	2
3	ELECTRICAL CONNECTIONS	3
3.1	Connection Diagram.....	3
3.2	Back Panel.....	5
4	OVERVIEW	6
4.1	Keypad and Display.....	6
4.2	Function Groups.....	7
4.3	Control Concept.....	8
5	MEASUREMENT	9
5.1	Display in Measurement mode.....	9
5.2	Security Codes.....	9
6	CALIBRATION	11
6.1	pH Calibration.....	11
6.2	ORP – mV Calibration.....	12
6.3	ORP – % Calibration.....	13
7	ADVANCED SET UP MODE	14
7.1	Electrode Offset (OFS) sub-function.....	14
7.2	Setting temperature (Set °C) sub-function.....	14
7.3	Control Relay A/ Control Relay B (SP1/SP2) sub-function.....	16
7.4	Controller (Cntr) sub-function.....	18
7.5	Current Output (mg) sub-function.....	20
7.6	Configuration (ConF) sub-function.....	21
7.7	Calibration (CAL) sub-function.....	24
8	ADVANCED SET UP MODE	25
8.1	Auto mode (mode after switch-on).....	25
8.2	Manual mode.....	25
9	TECHNICAL SPECIFICATIONS	26
10	ACCESSORIES	28
11	GENERAL INFORMATION	29
11.1	Warranty.....	29
11.2	Packaging.....	29
11.3	Return of Goods.....	29
11.4	Guidelines for Returning Unit for Repair.....	29
12	APPENDICES	30
12.1	Appendix 1.....	30
12.2	Appendix 2.....	31
12.3	Appendix 3.....	32
12.4	Appendix 4.....	33

1 INTRODUCTION

1.1 Description of Unit

Thank you for purchasing the ¼ DIN Alpha pH1000 pH/ORP process controller/transmitter. This unit is used for measuring either pH or ORP parameter one at a time, and the operational mode is switchable from the menu. You can use this unit to measure pH or ORP with limit control. This controller has many user-friendly and safety features which include:

- **Menu-driven program** that simplifies set-up
- **Built-in non-volatile memory backup** to ensure that calibration and other information are not erased if power supply fails
- **Press-button two-point calibration** and **electrode offset adjustment** from the keypad
- **Automatic temperature compensation (ATC)**
- **Manual temperature compensation** setting without the ATC probe, with independent setting for calibration and process temperature
- 0 to 2000 second **time delay adjustment** on all relays – minimise false alarms
- Separately adjustable **high and low set point hysteresis** (dead bands) prevent chattering of relays around the set points
- **Asymmetrical/symmetrical** input for pH/ORP operation
- **Three control modes:** limit, proportional pulse length or proportional pulse frequency
- **Large dual display LCD** for easy reading with clear multiple annunciators, alarm status, operational and error messages
- **Two switching contacts as set-point triggering relays**
- A third relay that can be set up to perform either **Alarm** or **Wash function**
- When set to work as **Alarm relay**, alerts you when readings exceed set-point limits after a set time buffer, and if the Pt100/Pt1000 wires are broken or disconnected during the ATC function
- **Programmable duration and frequency** in the Wash mode
- **Hold** function freezes output current (**0/4...20mA**) and releases control relays
- **LED indicators** signal control activities to monitor controller status from a distance
- **Protection against electromagnetic interference** – galvanically isolated 0/4...20mA output provides safety for datalogging and control purposes
- Choice of 7 buffers from **USA or NIST standards**

1.2 Applications

Use this controller in panel mounted enclosures for applications such as water treatment and monitoring, galvanic-decontamination, chemical processing food processing, clean or waste water control and neutralisation process.

3 ELECTRICAL CONNECTIONS

3.1 Connection Diagram



ENSURE electrical mains is disconnected before proceeding.

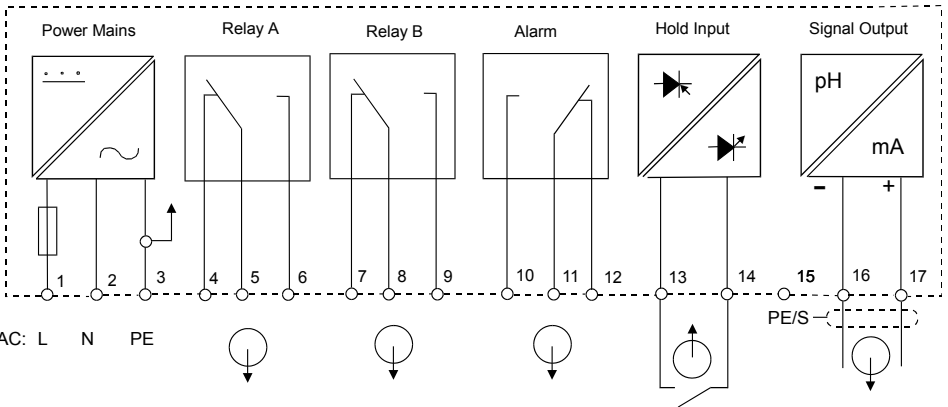
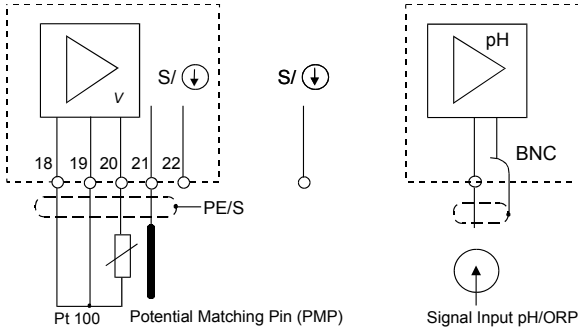

*) indicated contact positions are for currentless conditions

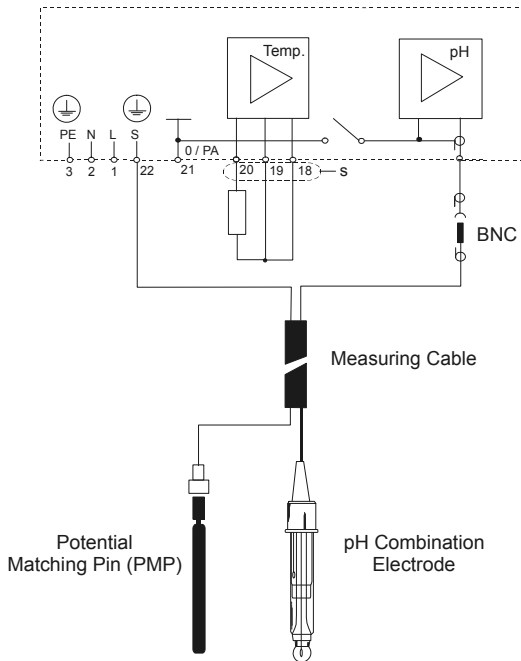

Symmetrical high-impedance connections

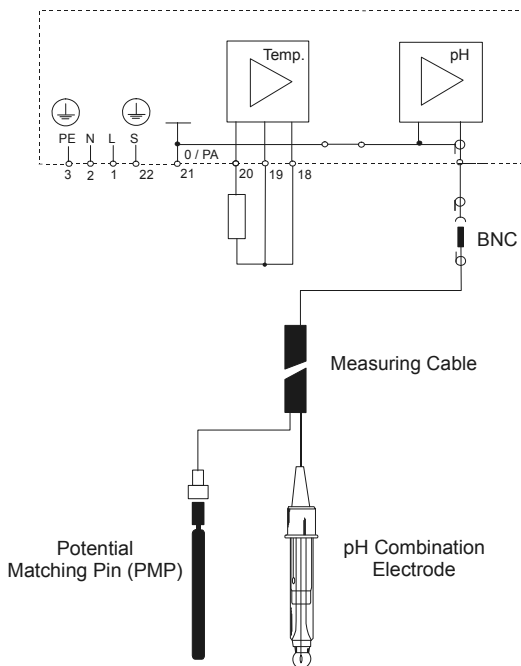

Asymmetrical connections

3.2 Back Panel



ENSURE electrical mains is disconnected before proceeding.

The back panel consists of two connectors. The first connector is the 17-way PCB edge connector and the other is the 5-way connector.

Connection for the 17-way screw terminals (from left to right):

- | | |
|---|--|
| 1. AC mains live wire | 10. Alarm/Wash relay working position (NO) |
| 2. AC mains neutral wire | 11. Alarm/Wash relay common |
| 3. AC mains protective earth wire | 12. Alarm/Wash relay resting position (NC) |
| 4. Low set relay resting position (NC) | 13. Hold function switch terminal 1 |
| 5. Low set relay common | 14. Hold function switch terminal 2 |
| 6. Low set relay working position (NO) | 15. No connection |
| 7. High set relay resting position (NC) | 16. 4 - 20 mA for -ve connection |
| 8. High set relay common | 17. 4 - 20 mA for +ve connection |
| 9. High set relay working position (NO) | |

Connections for the 5-way screw terminals:

18. Pt100/Pt1000 lead 1 terminal
19. Pt100/Pt1000 sense lead terminal
20. Pt100/Pt1000 lead 2 terminal

Note: If using a two-wire RTD, short terminal 19 to terminal 18.

Pt 100/Pt 1000 is selectable via an internal jumper. Factory default is Pt100. See Appendix 1 for directions on switching the RTD type.

21. pH/ORP (potential matching pin)
22. pH/ORP (shield)

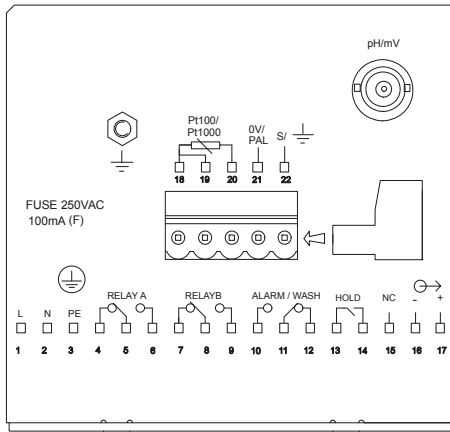

Important: The Alarm relay functions as an “Active Low” device i.e. it switches OFF under Alarm condition. Therefore, the Alarm display device should be connected to the ‘NC’ contacts of the relay (11 and 12). In the Wash mode, the relay works on a positive mode. Therefore, the Wash device should be connected to contacts 10 and 11.

4 OVERVIEW

4.1 Keypad and Display

4.1.1 Keypad



- Perform rapid 2-point calibration



- Allows entry to Set up mode
- Select individual functions within the function group of Set up mode
- Store input data in the Set up mode
- Start calibration in the calibration mode

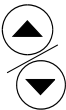

- Select various function groups in the Set up mode.
- Set parameters and numerical values in sub functions of Set up mode
If pressed continuously, the setting speed increases
- Return to the Measurement mode when both keys are pressed together
- Return to the Measurement mode when both keys are pressed together



- Switch between AUTO and MANUAL relay operation mode



- Display limit set-point values for the switch contacts in AUTO relay operation mode
- Switch between RELAY A and RELAY B in MANUAL relay operation mode

4.1.2 Display

The LCD display features two numerical displays that show status messages and measured values for easy, quick reference. The display provides short-text information for setting parameters and configuration.

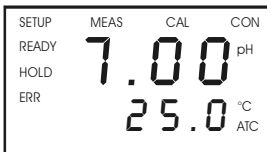

- **MEAS:** Measurement mode
- **SETUP:** Set-up mode of function groups
- **CAL:** Calibration mode of pH/ORP and temperature
- **READY:** Comes on after a successful calibration
- **HOLD:** Relay position and current output are frozen
- **ATC:** Comes on in the ATC mode. Disappears in the Manual temperature Compensation mode.
- “ATC” flashes if the temperature probe is faulty in its ATC mode
- **ERR:** Error or alarm indicator



- Display for RELAY A/B. Green LED indicates measured value within limit while RED LED indicates measured value outside limit.



- Alarm display if limit value overshoot or the ATC probe fails; with ERR annunciator appears on the display. Wash display if cleaning cycle is on.

4.2 Function Groups

The main function and sub-function groups are organised in a matrix format for configuration and selection of parameters. The main function groups are:

- 1) Offset adjustment (OFS)
- 2) Temperature Measurement / compensation settings (Set °C)
- 3) Control relay 1 configuration (SP1)
- 4) Control relay 2 configuration (SP2)
- 5) Control type (Cntr)
- 6) Current output (mg)
- 7) Configuration (ConF)
- 8) Calibration (CAL pH)

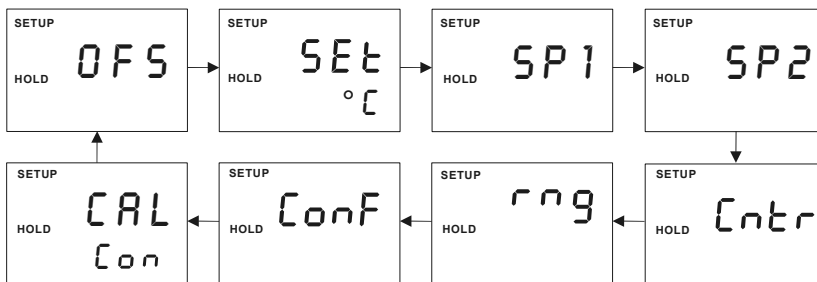

The set-up parameters can be viewed or changed by entering a security code. See section 5.2 for security code information.

4.2.1 How to view operating parameters without access to change them:

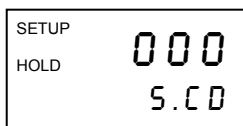

- a) Press the **Enter** key. The display will prompt the user to enter a security code (S.Cd). Leave the security code at "000" (do not enter a security code).
- b) Press **ENTER** key again. This allows you to only view (not change) any sub-functions' settings.
- c) Press the **▲** or **▼** key to scroll through the sub-functions.
- d) Press the **ENTER** key at a particular sub-function to view in detail.
- e) Press the **ENTER** key to return to the sub-function menu.
- f) Press the **▲** or **▼** keys simultaneously (as an Escape key) at any time to return to the Measurement mode.

Note: To simplify operations, the controller will not display parameters that are not relevant to a particular subfunction. For example, if the user set the controller for limit control, it will not display pulse length/frequency settings.

4.3 Control Concept

The main function and sub-function groups are organised in a matrix format as shown below. These functions can be accessed via the front keypad for configuration and selection of parameters.

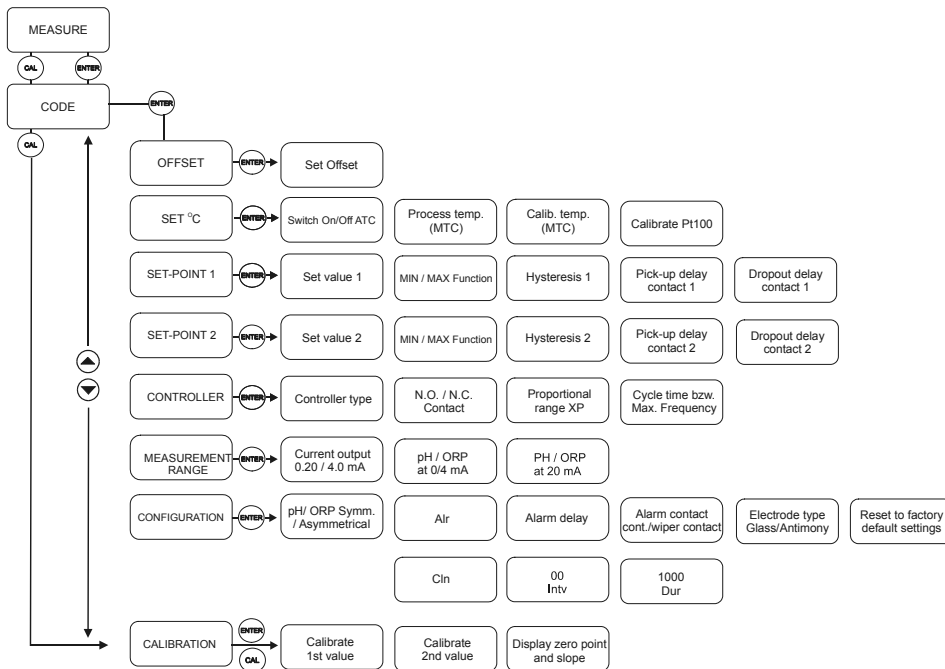

The controller offers two levels of password protection: (1) for direct access to calibration function and (2) for setting or editing specific controller parameters or functions in the SETUP mode to suit individual requirements.

Note: The passwords are not user-defined and have been set by factory. It is very important to keep these passwords strictly confidential to avoid unauthorised tampering of the system at all times.

Note: If the user reads parameters only, the controller automatically reverts to Measurement mode if no key is pressed for 30 seconds.

5 MEASUREMENT

5.1 Display in Measurement mode

When the controller is initially powered on, it automatically enters into the Measurement mode after the large dual LCD displays all segments briefly.

The upper display shows the measured pH or ORP value, while lower display shows either temperature value if controller is set for pH measurement or “OrP” if it is set for ORP measurement.

Annunciators at right side of display indicate whether controller is set for pH or mV measurement. If the controller is set for ORP % measurement, neither the pH or mV indicator displays.

Similarly annunciators or icons at top or left side of display show current status of controller, e.g. “MEAS”, “SETUP”, “CAL”, “READY”, etc. In addition, error messages also guide user in time of any faulty conditions as indicated by “ERR” or icons flashing.

5.1.1 Check electrode performance

To read current electrode slope and offset values without changing them:

- 1) **Press the CAL key** followed by the **ENTER** key without adjusting the security code (leave code at “000”). The upper display shows electrode slope. The lower display reading shows the pH reading at 0 mV.

Note: If security code is changed to a value other than “000”, **press the ENTER key** to return to Measurement mode, without displaying electrode information.

- 2) **Press the ENTER key** a second time to return to Measurement mode.

5.1.2 Checking set points

To read current set point values without changing them:

- 1) **Press the RELAY Selection (Rel A/Rel B) key.** The upper display shows the set point for Relay A; the lower display shows “SP1”.
- 2) **After** two seconds the upper display shows the set-point value for Relay B; the lower display shows “SP2”.
- 3) **After** an additional two seconds, the controller returns to its Measurement mode.

5.2 Security Codes

This controller has two levels of security protection with separate security codes. The first level allows entry into the Calibration mode: security code = 11; the second allows entry into the SETUP mode: security code = 22.

The security codes protect the controller from unauthorised tampering of its current setting. The parameters cannot be changed unless the security code is entered.

5.2.1 How to enter and change parameters in Calibration mode



- 1) **Press the CAL key.** The upper display shows “000” and the lower display shows “C.Cd” to prompt the user to enter the Calibration security code.
 - 2) **Press the ▲ or ▼ key** to scroll upper display to Calibration security code “11”.
 - 3) **Press the ENTER key.** If configured for pH control, the display shows “CAL pH”. If configured for ORP control, the display shows “CAL OrP”.
- display shows “CAL OrP”.
- 4) **Press ENTER key** again to begin calibration. Refer to Section 6 for full details on calibration.
 - 5) **Press the ▲ and ▼ keys simultaneously** (escape) to return to the Measurement mode.
- NOTE:** To view (not change) the SETUP parameters, press the **ENTER** key when the security code reads “000”.

5.2.1.1 Clearing the Calibration security code from the display

The calibration security code automatically resets from “11” to “000” after you return to Measurement mode, so you do not need to clear the security code from the display.

5.2.2 How to enter and change parameters in Advanced Setup mode

- 1) **Press the ENTER key** once. The upper display shows “000” and the lower display shows “S.Cd” to prompt you to enter the Advanced Setup security code.
 - 2) **Press the ▲ or ▼ key** to scroll the display to Setup security code “22”.
 - 3) **Press the ENTER key.**
 - 4) If configured for pH control, the upper display reads “OFS”.
 - 5) If configured for ORP control, the upper display reads “SP1”.
- NOTE:** Pressing the **ENTER** key at a value other than “22” causes the controller to revert to the Measurement mode.
- 6) You are now in the Advanced Setup mode. See Section 7 for complete instructions. To return to Measurement mode, **press the ▲ and ▼ keys simultaneously** (escape).
- NOTE:** If you want to view (not change) set up parameters, press the **ENTER** key when the security code reads “000”.

5.2.2.1 Clearing the Advanced Setup security code from the display

After you have entered the security code and returned to the Measurement mode, the security code “22” still appears on the display whenever you press the **ENTER** key. To conceal the security code, you must manually reset the code. To clear the Advanced Setup security code from the display:

- 1) **Press the ENTER key** in the Measurement mode.
 - 2) **Set to any security code** (not 11 or 22) and complete by pressing **ENTER**.
- NOTE:** When you enter the Calibration mode with code “11” or Advanced Setup mode with security code “22”, the unit automatically enters into the HOLD mode until you return back to Measurement mode. The HOLD annunciator is displayed at the upper left of the display. While on HOLD, the current output is frozen and set point relays are deactivated.

6 CALIBRATION

You can reach the Calibration mode directly from the Measurement mode by pressing the CAL key and entering the Calibration security code. You can also reach the Calibration mode from the Advanced Setup mode.

6.1 pH Calibration

This unit features 7 preset buffer values (1.01, 4.01, 6.86, 7.00, 9.00, 9.18 and 10.01) for fast auto calibration. When you calibrate this instrument, you need a standard pH buffer solution that matches one of these values.

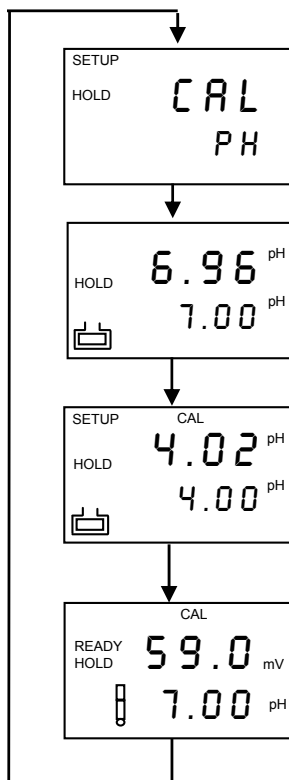

- 1) **Enter Calibration mode.** While in the Measurement mode, press the CAL key and scroll to Calibration code "11". Press the **ENTER** key again. The upper and lower display reads "CAL pH".
NOTE: If the display reads "CAL OrP", see section 7.6.2 for procedures on how to switch from ORP to pH readings.
- 2) **Press the ENTER key** again to begin calibration. The "CAL" indicator appears at the top of display and the buffer indicator appears in the bottom left corner of the display. The upper display shows your present uncalibrated reading. The lower display indicates one of the two buffer values used for the first point calibration. It would either be 7.00 or 6.86.
- 3) **Press the ▲ or ▼ key** to scroll the lower display to the buffer value that matches your buffer solution.
- 4) Make sure the electrode is in the buffer solution. In ATC, you must also immerse the temperature probe in the buffer solution. Likewise for symmetrical mode, you must also immerse the potential matching pin in the buffer.
- 5) **Press the ENTER key** to confirm the buffer value and start the calibration of its first point. The electrode indicator and CAL indicator both flash. The controller automatically adjusts the reading to match the buffer value.
- 6) The lower display will now show its next lower 'pH' buffer. Use **▲ and ▼ keys** to select its second buffer from one of the 5 preset values. Remove the electrode from the first buffer, wash and then immerse into the second buffer. Once the upper display stabilises **press**

the ENTER key, the electrode and CAL indicator will flash. The controller adjusts the reading to the buffer.

- 7) After calibrating to a second buffer value, this controller will automatically display slope in the upper display and zero point in the lower display. You can view the values for zero point and slope without calibration --- see section 5.1.2 for instruction The zero point and slope are re-determined after each calibration.

- 8) **Press the ENTER key.** If you entered the calibration mode **using the CAL key**, the controller will return to the Measurement mode. If you entered the calibration mode from the Advanced Set-up mode, the controller will return to the sub-function menu.

Note: If there is a calibration error, the controller displays "ERR". If this happens, press both the ▲ and ▼ keys (escape) to restart the calibration beginning from step 1.

Note: When calibrating with manual temperature compensation, the controller automatically changes from the preset process temperature to the calibration temperature. After leaving the Calibration mode, the controller switches back to process temperature (for setting the calibration temperature and the process temperature, see section 7.2.3).

6.2 ORP – mV Calibration

This mode allows one-point calibration.

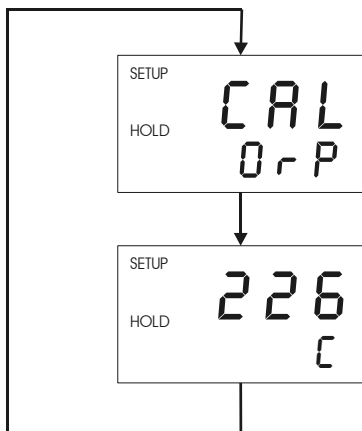

- 1) **Enter Calibration mode.** While in the Measurement mode, press the CAL key and scroll to Calibration code "11". **Press the ENTER key again.** The upper and lower display reads "CAL OrP".
NOTE: If the display reads "CAL pH", see section 7.6.2 for procedures on how to switch from pH to ORP mV readings.
- 2) Place sensor in the ORP solution.
- 3) **Press the ENTER key** to begin calibration. The "CAL" indicator appears on the display. The upper display shows the current mV output of the electrode without any offset adjustment.
- 4) **Press the ▲ and ▼ keys** to match the mV value to your exact reading.
- 5) To confirm, **press the ENTER key.** The controller calculates the correction factor and returns to the Measurement mode.

6.3 ORP – % Calibration

The ORP % mode allows you to calibrate at two points: a low concentration sample (20%) and a high concentration sample (80%).

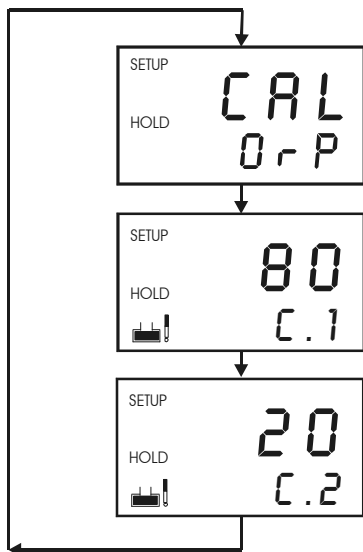

To calibrate the controller for ORP %:

- 1) **Enter Calibration mode.** While in the Measurement mode, press the CAL key and scroll to Calibration code "11". **Press the ENTER key again.** The upper and lower display reads "CAL OrP".
NOTE: If the display reads "CAL pH", see section 7.6.2 for procedures on how to switch from pH to ORP mV readings.
- 2) **Press the ENTER key** to begin calibration. The "CAL" indicator appears on the display. The upper display shows "80". The lower display shows "C1" (=calibrated value 80%).
- 3) Place sensor in the high concentration sample (relative value of 80%).
- 4) **Press the ENTER key** to confirm the value. The electrode indicator and CAL indicator flash. The unit automatically adjusts its reading to match the solution value.
- 5) The display will now show '20' and 'C2'. Remove the electrode from the first standard, wash it well and then immerse it in the 20% standard. When the display stabilises, **press the ENTER key.** The 'CAL' indicator flashes and the controller adjusts its display to the 20% relative value and exits to Measurement mode.

indicator flashes and the controller adjusts its display to the 20% relative value and exits to Measurement mode.

Note: If there is a calibration error, the controller displays "ERR", and it will not automatically return to Measurement mode. If this happens, press the ▲ and ▼ keys simultaneously (escape) to restart the calibration beginning from step 1.

Note: If you stop calibration after entering the first value, or if calibration is defective, the controller will use its original calibration data.

7 ADVANCED SET UP MODE

7.1 Electrode Offset (OFS) sub-function

You can perform electrode offset only in the pH mode. This mode allows you to change the offset parameter to make reading corrections without removing the electrode from the control system. You can make adjustments of up to ± 120 mV.

The controller will add or subtract the value from the measured pH and display the correct value. However, if you need to offset the value beyond the average offset you would expect in your application type, consider a full calibration or even electrode replacement.

- 1) Pull a sample from the system. Record the controller's pH reading at the time you take the sample.
- 2) Measure the pH of your sample using a calibrated pH tester, hand-held meter, or bench meter. Record the correct pH value.
- 3) **Enter Advanced set-up mode.** Press the ENTER key and scroll to Advanced Set-up security code "22". Press the ENTER key again.
- 4) **Press the ▲ or ▼ key** to scroll until the upper display shows OFS.
- 5) **Press the ENTER key.** The SETUP annunciator appears at the top of the display. The lower display shows the current measured pH value. The upper display shows the current offset value.
- 6) **Press the ▲ or ▼ key** until the pH value coincides with the correct pH value noted in Step 2. As the ▲ and ▼ keys are pressed to adjust the pH value, you will see that the 'offset' value in its upper display also changes.
- 7) **Press the ENTER key** to enter the offset value.

Note: The offset value is reset during full calibration. See Section 6 for full calibration instructions.

Note: The offset parameter is blanked out during ORP operation.

7.2 Setting temperature (Set °C) sub-function

7.2.1 Selecting automatic or manual temperature compensation

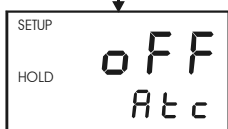
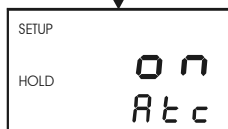
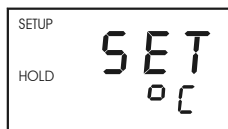

- 1) **Enter Advanced Set-up mode.** Press the ENTER key and scroll to Advance Set-up security code "22". Press the ENTER key again.
- 2) **Press ▲ and ▼ keys** to scroll until display shows "Set °C".
- 3) **Press ENTER key.** The lower display shows "Atc"; upper display shows "on" or "oFF" depending on whether or not ATC is selected.
- 4) **Press ▲ and ▼ keys** to toggle between ATC on and off.
- 5) Proceed with additional Advanced Set-up procedures (press ENTER again) or return to Measurement mode by pressing ▲ and ▼ keys (escape) simultaneously.

7.2.2 Temperature calibration (ATC mode only)

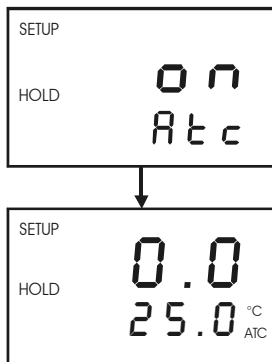

- 1) Select "ATC on" as described above in Section 7.2.1.
- 2) **Press ENTER key.** The upper display indicates current temperature offset. The current measured temperature is shown in the lower display.
- 3) Compare the current measured temperature on the controller display to a thermometer known to be accurate. Note down the correct temperature value.
- 4) **Press ▲ and ▼ keys** to scroll the lower display to match the correct value. Upper display will now show the offset value. You can offset temperature up to ± 5 °C.
- 5) **Press ENTER key** to confirm your selection.
- 6) Continue with additional Advanced Set-up procedures, or return to the Measurement mode by pressing ▲ and ▼ keys (escape) simultaneously.

7.2.3 Setting manual temperature compensation

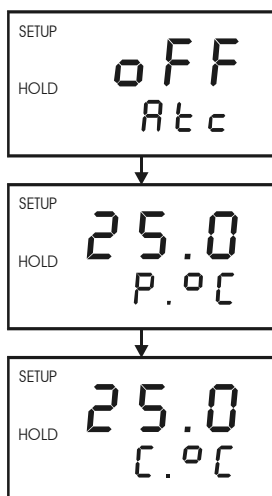

Note: This option is not available when the controller is set for ATC operation.

For manual temperature compensation, two different temperatures: process and calibration, can be input independently. This allows calibration at a temperature other than the process temperature. Example: setting a calibration temperature of 25°C allows calibration using standard buffer solutions at 25°C, even if the process temperature is different.

- 1) Select "ATC off" as described above in section 7.2.1
- 2) **Press ENTER key.** Upper display shows current process temperature and lower display shows "P.°C" to indicate process temperature.
- 3) **Press ▲ and ▼ keys** to adjust the process temperature value, between -9.9 and 125°C.
- 4) After setting the process temperature value, **press ENTER key.** Upper display shows current calibration temperature and lower display shows "C.°C".
- 5) **Press ▲ and ▼ keys** to adjust the calibration temperature value, between -9.9 and 125°C.
- 6) **Press ENTER key to confirm.**
- 7) Continue with additional Advanced Set-up procedures, or return to Measurement mode by pressing ▲ and ▼ (escape) simultaneously.

7.3 Control Relay A/ Control Relay B (SP1/SP2) sub-function

The SP1 option sets operating parameters for Relay A; the SP2 option sets operating parameters for relay B. Since these groups have the same set-up parameters, they are described together.

7.3.1 Entering Set point 1 (Set point 2) sub-function

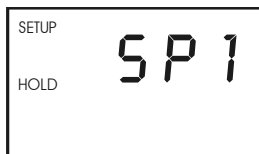

- 1) **Enter Advanced Set-up mode.** Press the ENTER key and scroll to Advanced Set-up security code “22”. Press the ENTER key again.
- 2) **Press ▲ or ▼ key** to scroll until upper display shows SP1 (SP2).

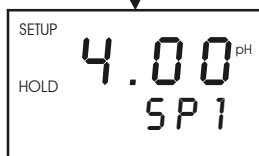

7.3.2 Selecting set point values

This lets you choose the value that will cause your controller to activate (i.e. pH 9.0).

- 1) **Follow directions in 7.3.1** to enter Control Relay mode. If you are in this mode, skip to step 2.
- 2) **Press ENTER key.** The upper display shows current set point value and lower display shows SP1 (SP2).
- 3) **Press ▲ or ▼ key** to enter value for Set point 1 (Set point 2). Your controller will activate at the value you select.
- 4) **Press ENTER key** to confirm your selection.
- 5) Proceed to 7.3.3 step 3, or return to Measurement mode by pressing the ▲ and ▼ keys simultaneously (escape).

7.3.3 Choosing High or Low set points

Select a low set point to activate controller when the pH/ORP value goes below the low set point; select a high set point to activate controller when the value overshoots the high set point. Using both SP1 and SP2, you can select lo/lo, lo/hi, hi/lo, or hi/hi set points.

- 1) **Follow directions in 7.3.1** to enter Control Relay mode.
- 2) **Press ENTER key.** Scroll with the ▲ or ▼ keys until upper display shows Lo or Hi (for low or high set point) and the lower display shows SP1 (SP2).
- 3) **Press the ▲ or ▼ keys** to select low (lo) or high (hi) set point for SP1 (SP2).
- 4) **Press ENTER key** to confirm your selection.
- 5) **Proceed to 7.3.4 step 3,** or return Measurement mode by pressing the ▲ and ▼ keys simultaneously (escape).

7.3.4 Selecting a hysteresis (dead band) value

Hysteresis prevents rapid contact switching if your value is fluctuating near the set point. It does this by overshooting the set point value to a specified hysteresis value. You can set the hysteresis value from 0.1 to 1.0 pH, 10 to 100mV or 1 to 10%.

Example: You have set your high set point at pH 9.0 and your hysteresis limit value at pH 0.5. If your measured value overshoots the high set point pH 9.0, the controller's relay activates, which in turn activates an external device such as a pump or valve. The actions of the external device will cause the solution's pH to drop. When the pH drops to 8.5 pH, the relay and hence the pump will switch off.

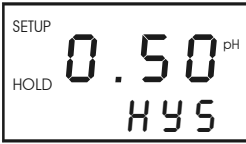

- 1) **Follow directions in 7.3.1** to enter Control Relay mode.
- 2) **Press the ENTER key.** Scroll with the ▲ or ▼ key until the upper display shows the hysteresis (dead band) value and the lower display shows "HYS".
- 3) **Press the ▲ or ▼ keys** to enter your hysteresis value for Set point 1 (Set point 2). Your controller will activate at the value you select.

- 4) **Press the ENTER key** to confirm your selection.
- 5) **Proceed to 7.3.5 step 3,** or return to Measurement mode by pressing the ▲ and ▼ keys simultaneously (escape).

NOTE: Please refer to Appendix 3 for a graphical representation of the Hysteresis.

7.3.5 Setting an on-delay time lag

You can set a time delay for each relay, which stops the relay from switching on the moment the set point is exceeded. This controller lets you set a 0 to 2000 second time delay before the relay activates.

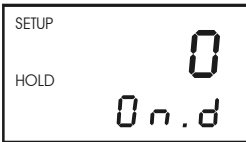

- 1) **Follow directions in 7.3.1** to enter Control Relay mode.
- 2) **Press the ENTER key.** Scroll with the ▲ or ▼ key until the upper display shows "on delay" time and the lower display shows "On.d".
- 3) **Press the ▲ or ▼ key** to enter on-delay time for Set point 1 (Set point 2). The controller will delay activation for the number of seconds (0 to 2000) you select.

- 4) **Press the ENTER key** to confirm your selection.
- 5) **Proceed to 7.3.6 step 3,** or return to Measurement mode by pressing the ▲ and ▼ keys simultaneously (escape).

7.3.6 Setting an off-delay time lag

You can set a time delay for each relay, which stops the relay from switching off the moment the value reached the set point and hysteresis. This controller lets you set a 0 to 2000 second time delay before your relay deactivates.

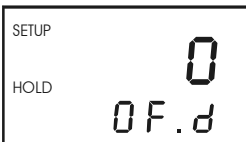

- 1) **Follow directions in 7.3.1** to enter Control Relay mode.
- 2) **Press the ENTER key.** Scroll with the ▲ or ▼ key until the upper display shows "off delay" time and the lower display shows "OF.d".
- 3) **Press the ▲ or ▼ key** to enter on-delay time for Set point 1 (Set point 2) Your controller will delay activation for the number of seconds (0 to 2000) you select.

- 4) **Press the ENTER key** to confirm your selection.
- 5) Continue with Advanced Set-up mode procedures, or return to Measurement mode by pressing the ▲ and ▼ keys simultaneously (escape).

7.4 Controller (Cntr) sub-function

You can set the controller's parameters in this sub-function.

7.4.1 Entering Controller sub-function

- 1) **Enter Advanced Set-up mode.** Press the ENTER key and scroll to Advanced set-up security code "22". Press the ENTER key again.
- 2) **Press the ▲ or ▼ key** to scroll until upper display shows "Cntr".

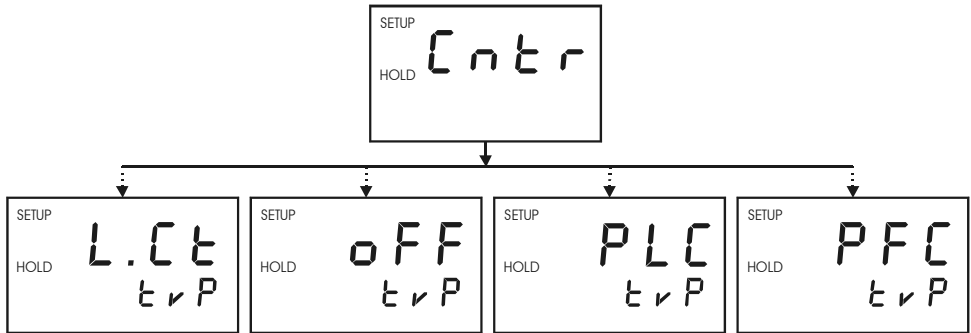

7.4.2 Choosing the controller type (limit or proportional)

This mode lets you choose your controller type: limit control, pulse length frequency proportional control, or control off.

- Use limit control with pumps or valves for fast response.
 - Use pulse frequency proportional control to operate your pumps smoothly.
 - Use pulse length proportional control for precise control of proportioning valves.
 - Use control off to operate controller as a monitor only or to keep relays from switching.
- 1) **Follow directions in 7.4.1** to enter Controller mode.
 - 2) **Press the ENTER key.** The upper display shows the current controller type and the lower display shows "tyP".
 - 3) **Press the ▲ or ▼ key** to select your controller type.
 - L.Ct = limit value pickup (on/off control).
 - oFF = controller off.
 - PLC = pulse length control.
 - PFC = pulse frequency control.
 - 4) **Press the ENTER key** to confirm your selection.
 - 5) **Proceed to 7.4.3 step 3**, or return to Measurement mode by pressing the ▲ and ▼ keys simultaneously (escape).

7.4.3 Choosing break/make contact relay type

Note: If the controller type "oFF" is set, the parameters listed in 7.4.3, 7.4.4 and 7.4.5 are blanked out. This mode lets you determine the relay state under Non-Alarm condition – dEEN (de-energised) or EN (energised).



- 1) **Follow directions in 7.4.1** to enter Controller mode.
- 2) **Press the ENTER key.** Scroll until the lower display shows “rEL” and the upper display shows the current selection (de-energised = dEEN or energised = EN).
- 3) **Press the ▲ or ▼ key** to choose de-energised or energised relay state.
- 4) **Press the ENTER key** to confirm your selection.
- 5) **Proceed to 7.4.4 step 3**, or return to Measurement mode by pressing the ▲ and ▼ keys simultaneously (escape).

7.4.4 Selecting proportional range value Xp

Note: If the controller type “oFF” or “L.Ct” is set, the parameters listed in 7.4.4 and 7.4.5 are blanked out.

This mode lets you set a band as a percentage of its full scale value. You can select this range from 10 to 200%, and the lower display shows “PrP”.

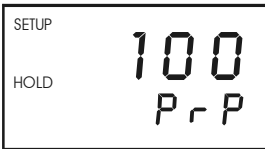

- 1) **Follow directions in 7.4.1** to enter Controller mode.
- 2) **Press the ENTER key.** Scroll until the upper display shows the proportional range (a number from 10 to 200%), and the lower display shows “PrP”.
- 3) **Press the ▲ or ▼ key** to choose the proportional range value Xp.
- 4) **Press the ENTER key** to confirm your selection.
- 5) **Proceed to 7.4.5 step 3**, or return to Measurement mode by pressing the ▲ and ▼ keys simultaneously (escape).

7.4.5 Maximum Pulse Length (tPL) or Maximum Frequency (FPF)

Note: If the controller type “oFF” or “L.Ct” is set, the parameters listed in 7.4.4 and 7.4.5 are blanked out.

This mode lets you set the maximum pulse length or the maximum frequency at which the relay will operate.

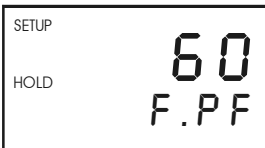
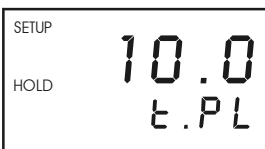

- 1) **Follow directions in 7.4.1** to enter Controller mode.
- 2) **Press the ENTER key.** Scroll until the lower display shows “t.PL” or “F.PF”.
 - In PLC (pulse length) mode: The lower display shows “t.PL” to indicate pulse length. The upper display shows your current pulse length. You can select any value from 0.5 to 20 seconds.
 - In PFC (pulse frequency) mode: The lower display shows F.PF to indicate pulse frequency. The upper display shows your current maximum pulse rate. You can select any value from 60 to 120 pulses per minute. When the measured value exceeds the Proportional Band in 7.4.4, the controller will pulse the relay at this rate.
- 3) **Press the ▲ or ▼ key** to choose the period duration or maximum frequency, depending on your mode.
- 4) **Press the ENTER key** to confirm your selection and to return to Advanced Set-up mode, or return to Measurement mode by pressing the ▲ and ▼ keys simultaneously (escape).

NOTE: The alarm contact is always of the fail-safe type: in the event of power failure the alarm is triggered.

7.5 Current Output (rng) sub-function

This sub-function lets you set the controller current output range of this unit.

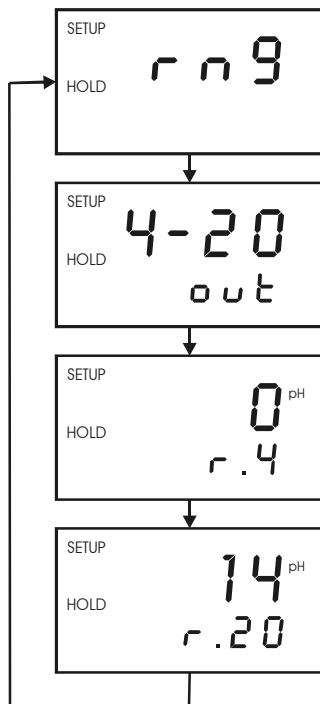

7.5.1 Entering current output sub-function

- 1) **Enter Advanced Set-up mode.** Press the ENTER key and scroll to Advanced Set-up security code “22”. Press the ENTER key again.
- 2) **Press the ▲ or ▼ key** to scroll until the upper display shows “rng”.

7.5.2 Choosing the output type

This parameter lets you choose between 0-20 mA or 4-20 mA output.

- 1) **Follow directions in 7.5.1** to enter Current Output mode.
- 2) **Press the ENTER key.** Scroll with the ▲ or ▼ key until the upper display shows the output type (0-20 or 4-20), and the lower display shows “out”.
- 3) **Press the ▲ or ▼ key** to select your output type: 0-20 or 4-20 mA.
- 4) **Press the ENTER key** to confirm your selection.
- 5) **Proceed to 7.5.3 step 3,** or return to Measurement mode by pressing the ▲ and ▼ keys simultaneously (escape).

7.5.3 Selecting pH/ORP value at 0(4)mA

This parameter lets you choose a pH or ORP value at which the controller output will be 0(4) mA. **NOTE:** If you are in the

pH mode, ORP parameters are blocked out. If you are in the ORP mode, pH parameters are blocked out.

- 1) **Follow directions in 7.5.1** to enter Current Output mode.
- 2) **Press the ENTER key.** Scroll with the ▲ or ▼ keys until the upper display shows a pH or ORP value and the lower display shows “r.0(4)”.
- 3) **Press the ▲ or ▼ key** to select pH or ORP value to be equivalent to 0(4) mA.
- 4) **Press the ENTER key** to confirm your selection.
- 5) **Press the ENTER key** to return to Advanced Set-up mode, or return to Measurement mode by pressing the ▲ and ▼ keys simultaneously (escape).

7.5.4 Selecting pH/ORP value at 20mA

This parameter lets you choose a pH or ORP value at which the controller output will be 20 mA. **NOTE:** If you are in the pH mode, ORP parameters are blocked out. If you are in the ORP mode, pH parameters are blocked out.

- 1) **Follow directions in 7.5.1** to enter Current Output mode.
- 2) **Press the ENTER key.** Scroll with the ▲ or ▼ keys until the upper display shows a pH or ORP value and the lower display shows “r.20”.
- 3) **Press the ▲ or ▼ key** to select pH or ORP value to be equivalent to 20 mA.
- 4) **Press the ENTER key** to confirm your selection.
- 5) **Press the ENTER key** to return to Advanced Set-up mode, or return to Measurement mode by pressing the ▲ and ▼ keys simultaneously (escape).

7.6 Configuration (ConF) sub-function

This group of parameters lets you configure the controller to suit your requirements.

7.6.1 Entering the Configuration sub-function

- 1) **Enter Advanced Set-up mode.** Press the ENTER key and scroll to Advanced Set-up security code "22". Press the ENTER key again.
- 2) **Press the ▲ or ▼ key** to scroll until the upper display shows "ConF".

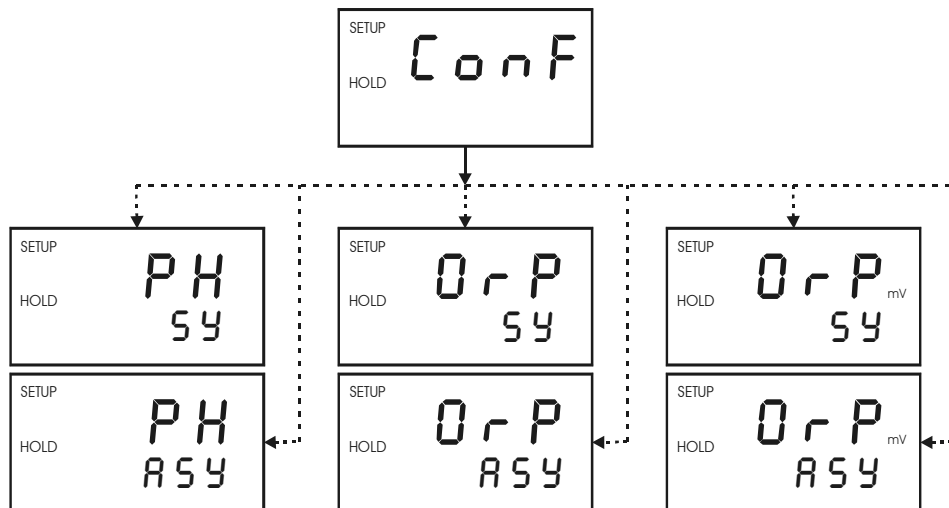

7.6.2 Selecting pH, ORP% or ORP mV measurement

This parameter group lets you select pH, mV, or % readings, and input type symmetrical or asymmetrical. Symmetrical mode is used in conjunction with a potential matching pin – in an electrically noisy environment.

Please refer to section 3, page 6 for a graphical representation.

- 1) **Follow directions in 7.6.1** to enter Configuration mode.
- 2) **Press the ENTER key.** Scroll with the ▲ or ▼ key until the upper display shows the control type (pH, ORP mV or ORP %) and the lower display shows symmetrical (SY) or asymmetrical (ASY) input type. Choose ORP without the mV indicator for ORP% readings.
- 3) **Proceed to 7.6.3**, or return to Measurement mode by pressing the ▲ and ▼ keys simultaneously (escape).

7.6.3 Selecting Alarm or Wash function

This function allows you to use the Alarm relay as Wash contact. The Wash contact is used in combination with automatic cleaning systems. During the wash cycle, the analogue output is set on hold.

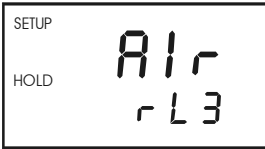

- 1) Follow direction in 7.6.1 to enter Configuration mode.
- 2) Press the ENTER key until upper display shows "Alr" or "CLn".
- 3) Press the ▲ or ▼ key to choose the desired function.
- 4) Press the ENTER key to confirm your selection.

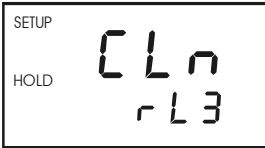

7.6.4 Selecting the alarm time lag if relay 3 has been set to Alarm mode

This parameter group lets you select a period of time before the alarm activates when your set point has been overshoot. You can select from 0 to 2000 seconds.

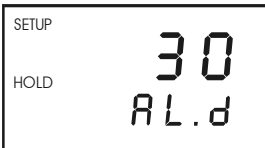

- 1) Follow directions in 7.6.1 to enter Configuration mode.
 - 2) Press the ENTER key. Scroll with the ▲ or ▼ key until the upper display shows a numerical value (in seconds) and the lower display shows "AL.d".
 - 3) Press the ▲ or ▼ key to select how long of an alarm delay (0 to 2000 seconds) you want.
 - 4) Press the ENTER key to confirm your selection.
- 5) Proceed to 7.6.4 step 3, or return to Measurement mode by pressing the ▲ and ▼ keys simultaneously (escape).

7.6.5 Selecting steady or pulse contact for the alarm relay

This parameter group lets you select whether the alarm contact will operate as a steady contact or a fleeting (single pulse) contact. Pulse contact closing time is 1 second.

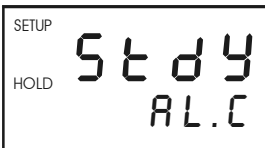

- 1) Follow directions in 7.6.1 to enter Configuration mode.
- 2) Press the ENTER key. Scroll with the ▲ and ▼ keys until the upper display shows "StdY" or "FLEt" and lower display shows "AL.C".
 - AL.C = alarm contact
 - StdY = steady contact
 - FLEt = fleeting (single pulse) contact
- 3) Press the ▲ or ▼ key to select steady or pulse contact.
- 4) Press the ENTER key to confirm your selection.
- 5) Proceed to 7.6.5 step 3, or return to Measurement mode by pressing the ▲ and ▼ keys simultaneously (escape).

7.6.6 Configuring the Wash contact if relay 3 has been set to the Wash mode

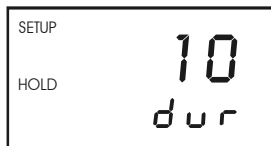
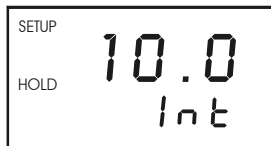
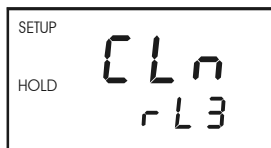

- 1) Follow direction in 7.6.1 to enter Configuration mode.
- 2) Press the **ENTER** key until upper display shows "Air" or "CLn".
- 3) Press the **▲** or **▼** key to select the "CLn" function. Press the **ENTER** key.
- 4) Press the **▲** or **▼** key to select the wash cycle (int. 0.1 to 199.9 hours) and press **ENTER**.
- 5) Press the **▲** or **▼** key to select the wash duration (1 to 1999 seconds) and press **ENTER**.

Note: During wash cycle, the controller is set to HOLD. For safety reasons, the HOLD function starts 5 seconds before the start of wash cycle and will continue for 10 seconds after the wash cycle is completed.

7.6.7 Selecting pH sensor type

Note: This parameter is blocked out in ORP mode. Proceed to 7.6.6.

Note: After each changeover, the factory calibration data for zero point and slope are overwritten. Be sure to recalibrate (see section 6).

This parameter group lets you configure the controller for glass or antimony electrodes. Use an antimony electrode for systems with hydrofluoric acid content.



- 1) Follow directions in 7.6.1 to enter Configuration mode.
- 2) Press the **ENTER** key. Scroll with the **▲** or **▼** key until the upper display shows "GLAS" or "AntY" and lower display shows "EL".
 - EL = electrode
 - GLAS = glass
 - AntY = antimony
- 3) Press the **▲** or **▼** key to select glass or antimony.
- 4) Press the **ENTER** key to confirm your selection.
- 5) Proceed to 7.6.6 step 3, or return to Measurement mode by pressing the **▲** and **▼** keys simultaneously (escape).

7.6.8 Reverting to factory default settings

Use this parameter to reset all settings to factory default.



- 1) **Follow directions in 7.6.1** to enter Configuration mode.
- 2) **Press the ENTER key** until the upper display shows “no”, “FCt” or “CAL”, and the lower display shows “deF” (default).
- 3) **Press the ▲ or ▼ key** to select “no” for using the old values, “FCt” to reset all settings to factory defaults or “CAL” to reset calibration values only to the factory default values.

WARNING: Changing from “no” to “FCt” or “CAL” and pressing the ENTER key resets all settings or the calibration values respectively to factory defaults.



- 4) **Press the ENTER key** to confirm your selection and to return to Advanced Set-up mode, or return to Measurement mode by pressing the ▲ and ▼ keys simultaneously (escape).



7.7 Calibration (CAL) sub-function

The calibration procedure in Advanced Set-up mode is identical to the procedure in the Calibration mode. The only difference is that the controller will revert back to Set-up mode (instead of Measurement mode) after calibration is completed.

7.7.1 Entering the Calibration mode from Advanced Set-up mode

- 1) **Enter Advanced Set-up mode.** Press the ENTER key and scroll to Advanced Set-up security code “22”. Press the ENTER key again.
- 2) **Press the ▲ or ▼ key** to scroll until the upper display shows “CAL”.
- 3) See Section 6 for complete calibration procedures.

8 AUTO/MANUAL MODE

Regardless of the mode, you can control devices connected to Relay A or Relay B from the front panel of this controller. In Automatic mode, the controller's set point values activate the relays. In Manual mode, you have manual control of the relays so you can prime the pump or check pump status without operating the entire system.

8.1 Auto mode (mode after switch-on)

In this mode, the controller set-point values activate the relays. To view the set-point values:

- 1) **Press the RELAY SELECTION (Rel A/Rel B) key.** The upper display shows your set-point value for Relay A; the lower display shows "SP1".
- 2) After two seconds the upper display shows your set-point value for Relay B; the lower display shows "SP2".
- 3) After an additional two seconds the controller will return to Measurement mode.

8.2 Manual mode

In this mode, you can manually turn on and off the control devices connected to Relay A or Relay B or both.

- 1) **Press the RELAY CONTROL (auto/manu) key.** The upper display shows "000"; the lower display shows "S.Cd" to prompt you to enter the Advanced Set-up code.
- 2) **Press the ▲ or ▼ key** to scroll the upper display until it reads "22".
- 3) **Press the ENTER key.** The manual indicator by the RELAY CONTROL key lights up.
Note: Pressing **ENTER** key at a value other than "22" will cause the controller to revert to Measurement mode, and the relays will remain in automatic mode.
- 4) Press the **RELAY SELECTION** key to select either Relay A or Relay B. The LED next to the currently selected relay (A or B) will light.

The manual control options now available will depend on the control type (limit, pulse frequency, or pulse length) you selected set in section 7.4.2.

- If you selected **Limit control:** Upper display reads the current measured value. Lower display shows "oFF" or "on" depending on the relay status of the currently selected relay.
 - If you selected **Pulse length control:** Upper display reads the current measured value. Lower display shows the current pulse duration.
 - If you selected **Pulse frequency control:** Upper display reads the current measured value. Lower display shows the current pulse frequency.
- 5) **Press the ▲ or ▼ key** to change the Relay on/off status, pulse length, or pulse frequency. LED indicators at the right of controller will change between Red and Green to indicate Relay status.

Note: If you wish to manually change the status of both relays, press the **RELAY SELECTION** key at this point and repeat step 5 for the second relay. This first relay will remain under manual control while you set the second relay.

- 6) Press the **RELAY CONTROL** key to return to Measurement mode. Relays are now back under automatic control.

9 TECHNICAL SPECIFICATIONS

pH Range	0.00 to 14.00 pH
<i>Resolution</i>	0.01 pH
<i>Relative Accuracy</i>	± 0.01 pH
mV Range	0 to 100.0% / -1000 to +1000 mV
<i>Resolution</i>	0.1% / 1mV
<i>Relative Accuracy</i>	± 1 mV
Temperature	- 9.9 to + 125.0 °C
<i>Resolution</i>	0.1 °C
<i>Relative Accuracy</i>	± 0.5 °C
Sensor	Pt 100 /Pt 1000 (jumper selectable)
Temperature Compensation	Auto / manual (reference at 25.0 °C)

Set-point and Controller Functions

Function (switchable)	limit controller pulse length/ frequency controller
Controller characteristics	proportional controller
Adjustable period with pulse length controller	0.5 to 20 sec.
Adjustable period with pulse frequency controller	60 to 120 pulses/min
Pickup / Dropout delay	0 to 2000 sec.
Switching pH hysteresis	0.1 to 1 pH
Switching ORP hysteresis	1 to 10.0% / 10 to 100 mV
Contact outputs, controller	2 potential-free change-over contacts
Switching voltage / current / power	max. 250 VAC / max. 3A / max. 600 VA

Alarm Functions

Function (switchable)	Latching / pulse
Wash cycle	0.1 to 199.9 hrs
Wash duration	1 to 1999 s
Pickup delay	0 to 2000 s
Switching voltage / current / power	max. 250 VAC / max. 3A / max. 600 VA

Electrical Data and Connections

Power Requirements	110 / 220 VAC (jumper selectable)
Frequency	48 to 62 Hz
Power Consumption	max. 7 VA
Signal Output / Load	4 to 20 mA, galvanically isolated
Load	Max. 600 Ω
pH / ORP input	BNC, screw terminals
Connection terminal	Terminal blocks 5-pole / 17-pole, removable
Mains fuse / fine wire fuse	slow-blow 250 V / 100 mA

EMC Specifications

Emissions	According to EN 50081-1
Susceptibility	According to EN 50082-1

Environmental Conditions (For Indoor Use)

Altitude	Up to 2000 m
Maximum Relative Humidity	80% up to 31 °C decreasing linearly to 50% at 40 °C
Power Supply	Mains supply voltage fluctuations not exceeding +10% of the nominal voltage
Transient Overvoltages	Category II
Pollution Degree	Category II
Ambient temp. operating range	-10 to +50 °C

Mechanical Specifications

Dimensions (control panel housing - L x H x W)	175 x 96 x 96 mm
Weights (control panel housing)	max. 0.7 kg
Material	ABS with polycarbonate (front housing)
Insulation (Front / Housing)	IP 54 / IP 40

10 ACCESSORIES

Replacement Unit

Product Description	Thermo Scientific Code no.	Eutech Code no.
Alpha-pH1000 pH/ORP Controller/Transmitter with 0/4-20 mA output and 110VAC Setting	TSPHCTP1001	ECPHCTP1001
Alpha-pH1000 pH/ORP Controller/Transmitter with 0/4-20 mA output and 220VAC Setting	TSPHCTP1002	ECPHCTP1002

Assembly Accessories

Product Description	Code no.
pH Combination Electrode with Pt 100 RTD and PMP	EC100GTSO05B
pH Combination Electrode with HF resistant glass (w/o ATC & PMP)	ECARTSOHF05B
pH Combination Electrode with PMP (w/o ATC)	ECARGTSO05B
pH Combination Electrode with high temperature resistance (110 oC) and high pressure resistance (9 bar) (w/o ATC & PMP)	ECARHTTSO05B
pH Combination Electrode (w/o ATC & PMP)	ECARTSO05B
ORP Gold Electrode with PMP but w/o ATC	ECHTAUTSO05B
ORP Platinum Electrode with PMP but w/o ATC	ECHTPPTS05B

Note: Above pH/ORP electrodes withstand up to 6 bar pressure except ECARHTTSO05B. These electrodes have integral 5m measuring cable terminating with a BNC connector. Please contact your authorised distributor or dealer for the prices of extension measuring cables and other accessories like tee joints, electrode assembly, and calibration solutions.

11 GENERAL INFORMATION

11.1 Warranty

Thermo Scientific warrants this product to be free from significant deviations in material and workmanship for a period of one year from the date of purchase. If repair is necessary and has not been the result of abuse or misuse within the warranty period, please return by freight pre-paid and amendment will be made without any charge. Our Customer Service Dept. will determine if product problem is due to deviations or customer abuse. Out of warranty products will be repaired on a charge basis.

11.2 Packaging

The instrument is packaged in a corrugated box with a warranty card, instruction manual and the following accessories:

- 17-way and 5-way (right-angled) terminal block [1 unit each]
- side threaded rod with catch [2 units]
- receptacle cable lug [1 unit]
- rubber gasket [1 unit]

11.3 Return of Goods

Authorisation must be obtained from our Customer Service Dept. to issue a RMA (Return of Material Authorisation) number before returning items for any reason. When applying for authorisation, please include data requiring the reason of return. Items must be carefully packed to prevent damage in shipment and insured against possible damage or loss. Thermo Scientific will not be responsible for any damage resulting from careless or insufficient packing.

Warning: Shipping damage as a result of inadequate packaging is the user/distributor's responsibility, whoever applicable. Please follow the guidelines below before shipment.

11.4 Guidelines for Returning Unit for Repair

Use the original packaging material, if possible when shipping the unit for repair. Otherwise wrap it with bubble pack and use a corrugated box for better protection. Include a brief description of any faults suspected for the convenience of Customer Service Dept., if possible.

12 APPENDICES

12.1 Appendix 1



Before opening the unit, **ENSURE** that the power cable is physically separated from the power supply.

Jumper Positions - Internal to the controller

JP 1	Selects the input voltage 220 VAC.
JP 2	Selects the input voltage 110 VAC.
JP 3	Solder bridge selects between Pt100 and Pt1000.
Fuse	Note that there is a fuse (slow-blow 100mA) internal to the controller. Replace fuse with the recommended type only.

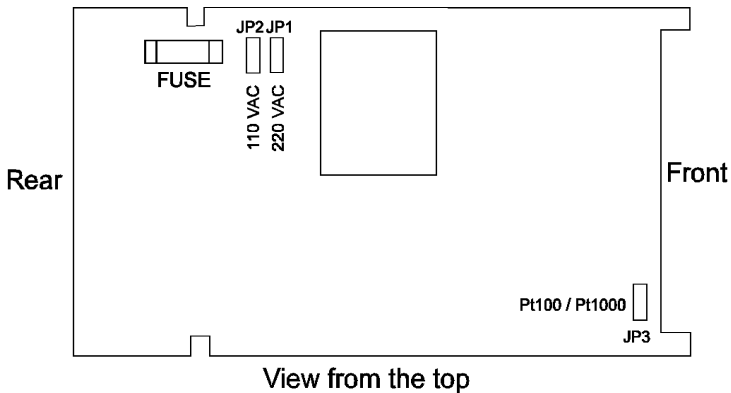

12.2 Appendix 2

The following table shows the various pH values at different temperature of the solution during calibration.

Temperature (°C)	pH 1.00	pH 4.01	pH 6.86	pH 7.00	pH 9.00	pH 9.18	pH 10.01
0	0.96	4.01	6.98	7.12	9.33	9.47	10.32
5	0.99	4.01	6.95	7.09	9.24	9.38	10.25
10	0.99	4.00	6.92	7.06	9.16	9.32	10.18
15	0.99	4.00	6.90	7.04	9.11	9.27	10.12
20	1.00	4.00	6.88	7.02	9.05	9.22	10.06
25	1.01	4.01	6.86	7.00	9.00	9.18	10.01
30	1.01	4.01	6.85	6.99	8.95	9.14	9.97
35	1.01	4.02	6.84	6.98	8.91	9.10	9.93
40	1.01	4.03	6.84	6.97	8.88	9.07	9.89
45	1.01	4.04	6.83	6.97	8.85	9.04	9.86
50	1.01	4.06	6.83	6.97	8.82	9.01	9.83
55	1.01	4.08	6.83	6.97	8.79	8.99	9.81
60	1.02	4.10	6.84	6.98	8.76	8.96	9.79
70	1.02	4.12	6.85	6.99	8.72	8.92	9.76
80	1.02	4.16	6.86	7.00	8.68	8.89	9.74
90	1.02	4.20	6.88	7.02	8.65	8.85	9.73

12.3 Appendix 3

Simple Explanation on the Function of Hysteresis

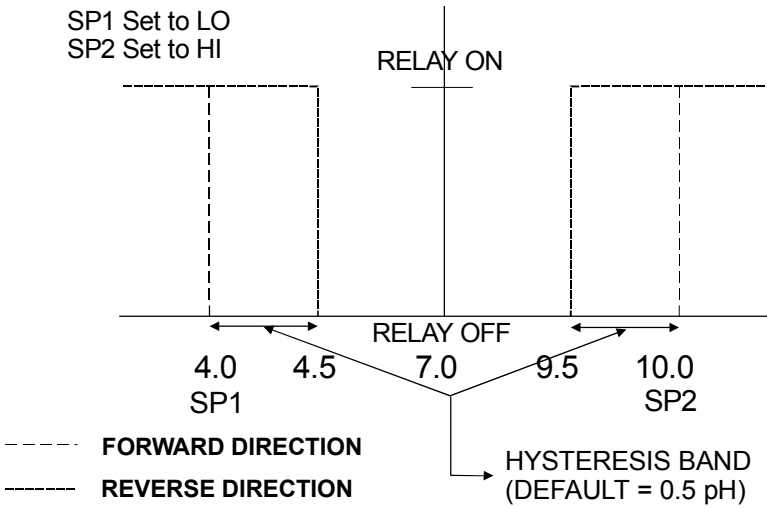

The controller relay activates when the set-point is reached. In the reverse direction, it does not de-activate when the value reaches the set-point. Instead, it continues to be active till the value reaches the amount set by the Hysteresis band.

12.4 Appendix 4

General Instructions Concerning Controller Setting

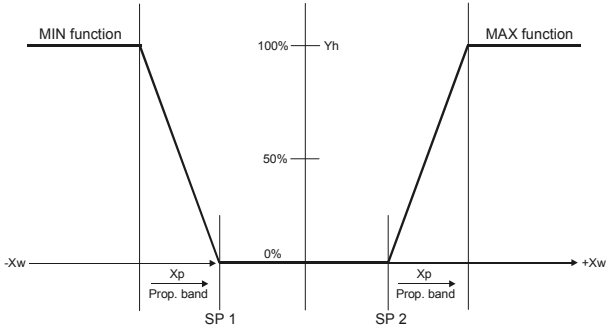

Control characteristic of P-Controller as proportional controller

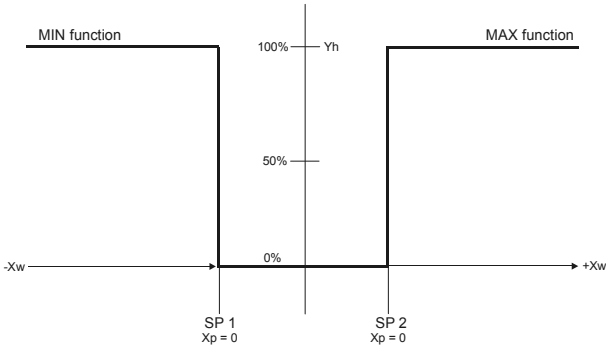

Control characteristic of P-Controllers as limit value switch

Characteristics of Pulse Length and Pulse Frequency

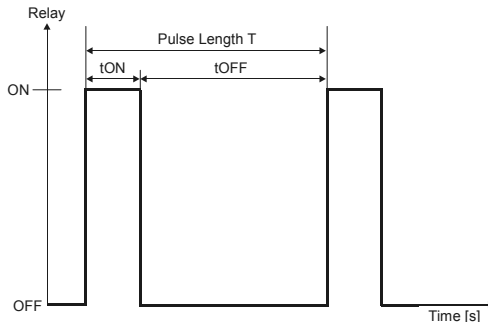

Controller signal of Pulse length controller

The output relay of the pulse length controller is clock-timed. The switching period T remains constant. Depending on the divergence from the limit value, the switch-on time t_{ON} is increased or decreased in accordance with the proportional range X_p .

The following applies:

$$t_{ON} + t_{OFF} = T \text{ (Const.)}$$

greater divergence \rightarrow greater t_{ON}

X_p exceeded $\rightarrow t_{ON} = T$ (relay remains picked up)

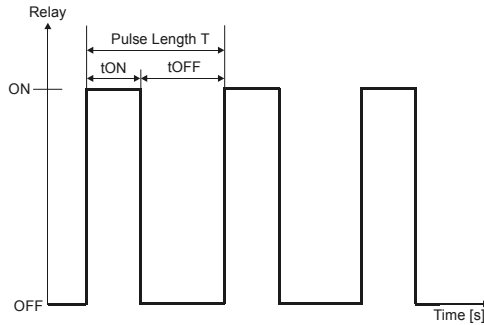

Controller signal of Pulse Frequency Controllers

The output relay of the pulse frequency controller is clock-timed. The pulse duration t_{ON} remains constant at 250mS.

Depending on the divergence from the limit value, the frequency ($1/t_T$) is increased or decreased in accordance with the proportional range X_p .

The following applies:

$$t_{ON} = \text{Const. (250 msec.)}$$

greater divergence \rightarrow greater f (greater frequency)

X_p exceeded \rightarrow max. frequency

For more information on Thermo Scientific products, contact your nearest distributor or visit our website listed below:

<p>Thermo Scientific Water Analysis Environmental Instruments Blk 55, Ayer Rajah Crescent, #04-16/24 Singapore 139949 Tel: (65) 6778 6876 Fax: (65) 6773 0836 E-mail: eutech@thermofisher.com Web-site: http://www.thermo.com/process</p>	<p>Oakton Instruments P.O Box 5136, Vernon Hills, IL 60061, USA Tel (in U.S.): 888-462-5866 Tel (outside U.S.): 1-847-549-7600 Fax: (1) 847-247-2984 E-mail: info@4oakton.com Web-site: http://www.4oakton.com</p>
<p>Distributed by:</p>	